

# DATA SHEET





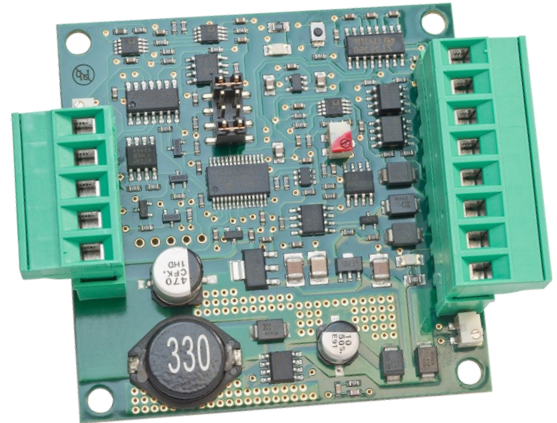

## O2I-Flex

### Oxygen Sensor Interface Board

#### FEATURES

- Provides the electronics necessary to power and control SST's range of zirconium dioxide (ZrO<sub>2</sub>) sensors
- Externally triggered automatic or manual calibration. Calibration can also be initiated via an on-board push button
- Power and sensor operating LEDs
- Removable polarised screw terminals for easy wiring



<p><b>Supply Voltage</b></p>  <p>24 V VOLTAGE</p>	<p><b>Temp</b></p>  <p>-10°C to +70°C TEMPERATURE</p>	<p><b>Digital Output</b></p>  <p>RS232</p>	<p><b>Analogue Output</b></p>  <p>0 - 10 V VOLTAGE</p>  <p>4-20mA CURRENT</p>	<p><b>Response Time</b></p>  <p>&lt; 4 secs</p>  <p>&lt; 15 secs</p>
---	---	--	--	---

#### BENEFITS

- Adaptive software filtering provides a fast sensor response coupled with a stable oxygen output
- High accuracy linear output
- Can be calibrated in fresh air (20.7% O<sub>2</sub>) or in any other known O<sub>2</sub> concentration

#### OUTPUT VALUES

Oxygen range (analogue output) <sup>3</sup>	0.1 <sup>2</sup> —25% O <sub>2</sub>
	or
	0.1 <sup>2</sup> —100% O <sub>2</sub>
Oxygen range (RS232 output)	0.1 <sup>2</sup> —100% O <sub>2</sub>
Accuracy after calibration <sup>4, 5</sup>	1% O <sub>2</sub>
Repeatability after calibration <sup>4</sup>	0.5% O <sub>2</sub>
Output resolution:	
0—10V <sub>DC</sub> :	0.01V
4—20mA:	0.01mA
RS232:	0.01% O <sub>2</sub>
Response time (step 10—90%)	
Fast response sensor connected:	< 4s
Standard response sensor connected:	< 15s
Initial warm up time (till stable output)	5—10mins
Output inactive start up delay (heater warm up)	60s

#### TECHNICAL SPECIFICATIONS

Supply voltage	24V <sub>DC</sub> ± 10%
Supply current	600mA max. at 24V <sub>DC</sub>
Digital output	RS232
Analogue output	4—20mA; load 100—600Ω
	or
	0—10V <sub>DC</sub> ; load 10kΩ min
Temperature limits	
Storage:	-10°C to +70°C
Operating:	-10°C to +70°C
Oxygen pressure limits <sup>1</sup>	1—1000mbar

**Need help? Ask the expert**  
**Tel: + 44 (0)1236 459 020**  
**and ask for "Technical"**



- 1) Sensor and interface for correct barometric pressure compensation.
- 2) Prolonged operation below 0.1% O<sub>2</sub> can damage the sensing element.
- 3) Range selectable by altering the position of the jumper links on the PCB; refer to PCB Layout on page 3.
- 4) Assuming barometric pressure (BP) remains constant.
- 5) As the O<sub>2</sub> sensor measures the partial pressure of oxygen (PPO<sub>2</sub>) within the measurement gas deviation in the BP from that present during calibration will cause readout errors proportional to the change, e.g. if the sensor reads 21% O<sub>2</sub> at 1013.25mbar and the BP increases by 1%, the sensor readout will also increase by 1% to 21.21% O<sub>2</sub>.

## OUTLINE DRAWING AND MOUNTING INFORMATION

All dimensions shown in mm. Tolerances =  $\pm 1$ mm.

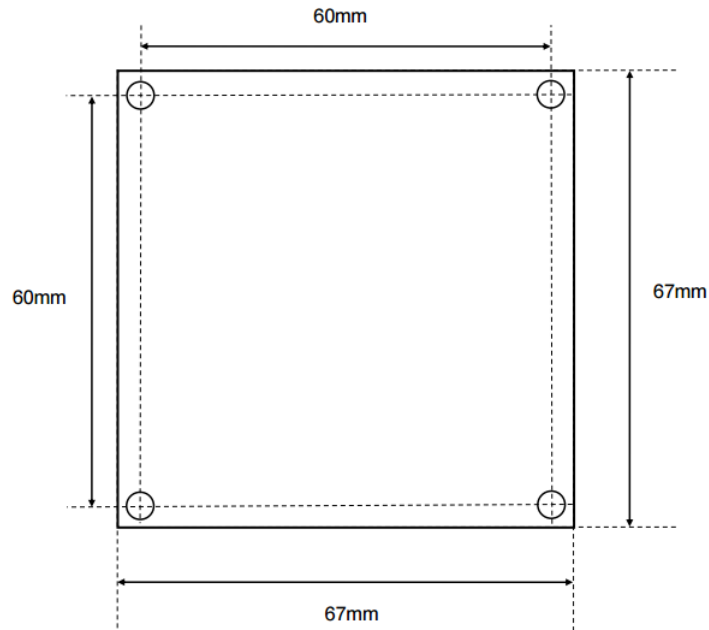

4 x M4 Mounting holes · 60x60mm pitch

## ELECTRICAL INTERFACE

Electrical overview shown below, for full details refer to [AN-0042](#) O2I-Flex Quick Start Guide.



Always handle the interface board using the correct ESD handling precautions.

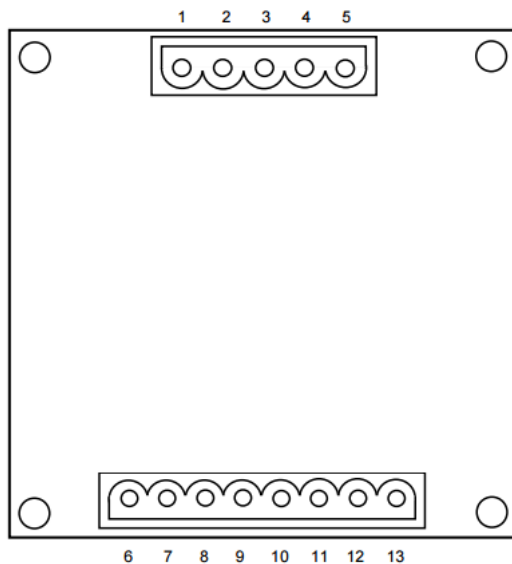

Pin	Assignment
1	Sensor Heater GND (1)
2	Sensor Heater + (2)
3	Sensor Sense
4	Sensor Common
5	Sensor Pump
6	24V <sub>DC</sub> $\pm$ 10%
7	GND
8	4—20mA Output
9	0—10V <sub>DC</sub> Output
10	Calibrate
11	Cycle
12	RS232 Tx
13	RS232 Rx

### Notes:

- Output pins 8, 9, 12 and 13 are all references to the supply GND (pin 7). Due to high current flow in the supply GND, when monitoring the 0—10V<sub>DC</sub> output (pin 9) it is recommended that a separate GND wire for the measurement system is taken from pin 7. This removes errors due to voltage drops in the power supply connections.
- Output pins 1 through 5, refer to appropriate SST oxygen sensor datasheet for wiring/pin designations.
- Every SST oxygen sensor has two heater connections which should be connected to pins 1 & 2 of the O2I-Flex; the heater coil has no polarity. However when connecting to a sensor where the sensor housing is one of the heater connections, pin 1 of the O2I-Flex should be connected to the housing.

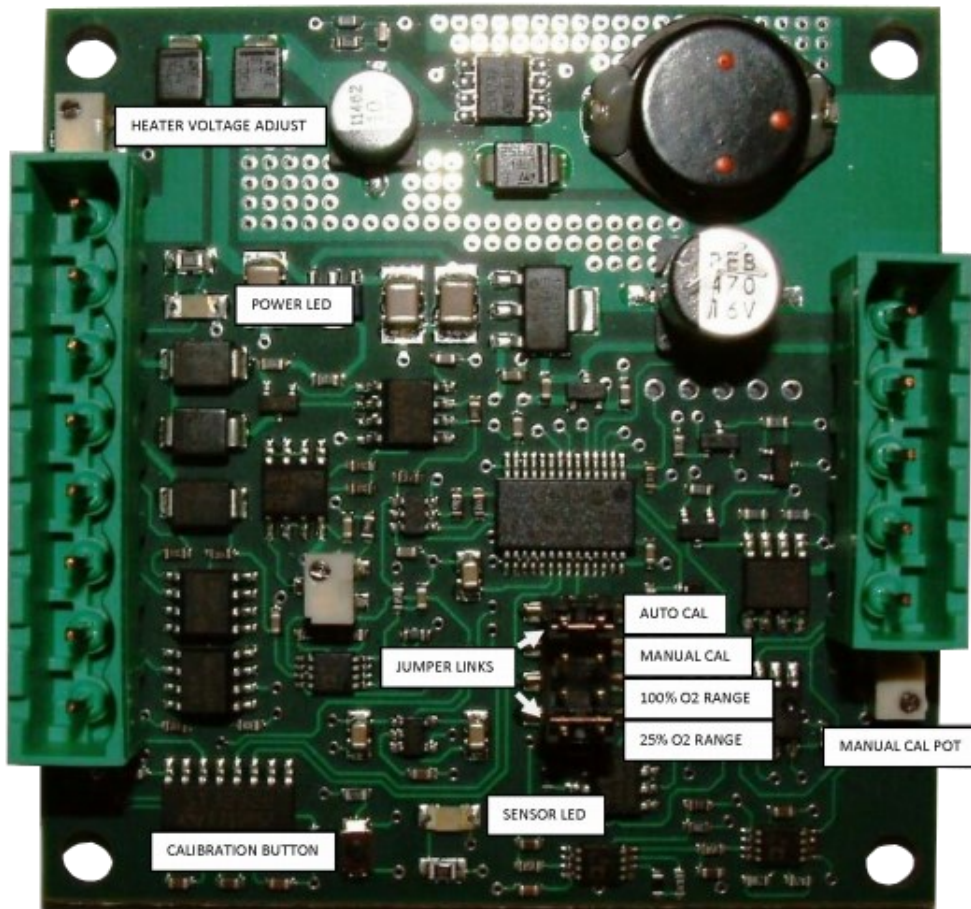
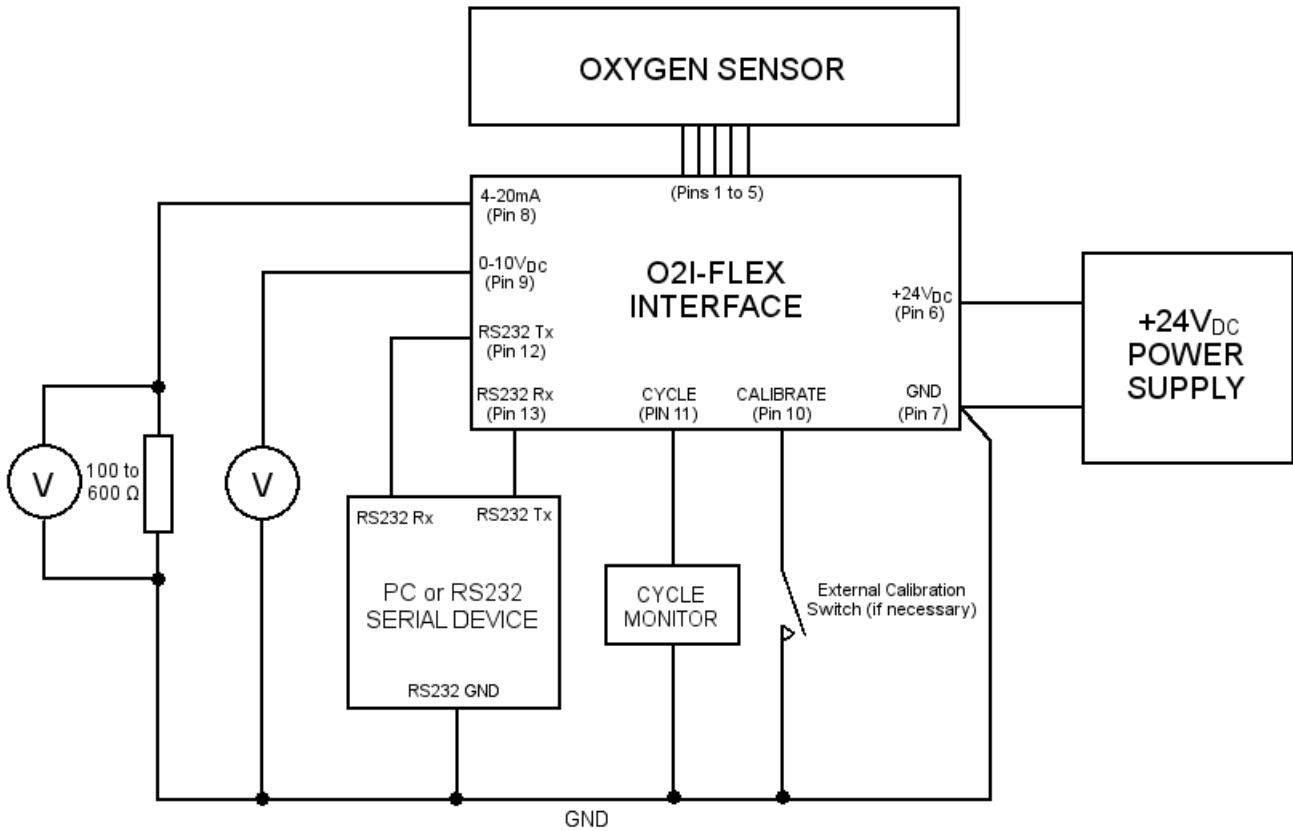

Specify the part number listed below when ordering.

O 2 I - F L E X

## RELATED PRODUCTS

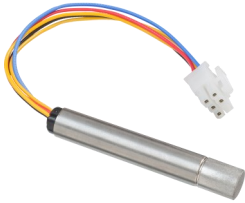

**ZrO<sub>2</sub> Probe Sensor—Short  
Housing**

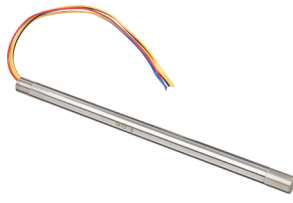

**ZrO<sub>2</sub> Probe Sensor—Long  
Housing**

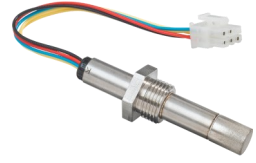

**ZrO<sub>2</sub> Screw Fit Sensor**

### CAUTION

Do not exceed maximum ratings and ensure sensor(s) are operated in accordance with their requirements.

Carefully follow all wiring instructions. Incorrect wiring can cause permanent damage to the device.

Zirconium dioxide sensors are damaged by the presence of silicone. Vapours (organic silicone compounds) from RTV rubbers and sealants are known to poison oxygen sensors and MUST be avoided.

Do NOT use chemical cleaning agents.

**Failure to comply with these instructions may result in product damage.**

### INFORMATION

As customer applications are outside of SST Sensing Ltd.'s control, the information provided is given without legal responsibility. Customers should test under their own conditions to ensure that the equipment is suitable for their intended application.

For detailed information on the sensor operation refer to application note AN0043 Operating Principle and Construction of Zirconium Dioxide Oxygen Sensors.

**For technical assistance or advice, please email:**  
[technical@sstsensing.com](mailto:technical@sstsensing.com)

**General Note:** SST Sensing Ltd. reserves the right to make changes to product specifications without notice or liability. All information is subject to SST Sensing Ltd.'s own data and considered accurate at time of going to print.