





## LuminOx O<sub>2</sub> Sensors

### Luminescence-based Optical Flow-Through Series

#### FEATURES

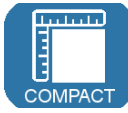
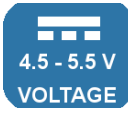
- Luminescence-based optical technology, NOT electrochemical
- Contains no hazardous materials; RoHS & REACH compliant
- Connects directly to a microcontroller without any additional circuitry
- Factory calibrated
- High accuracy, fast response
- Maintenance free<sup>a</sup>



<b>Housing</b>  COMPACT	<b>Supply Voltage</b>  4.5 - 5.5 V VOLTAGE	<b>Operating Temp</b>  +10°C to +45°C TEMPERATURE	<b>Output Digital</b>  TTL	<b>Response Time</b>  < 10 secs
---	---	--	---	---

#### BENEFITS

- Compact, flow-through housing with sealed base
- Low power, long life due to non-depleting sensing principle
- Low cost

#### TECHNICAL SPECIFICATIONS

Supply voltage (Vs)	4.5—5.5V <sub>DC</sub>
Supply current (Is)	<7.5mA (streaming one sample per second), <20mA Peak
Output Type	3.3V TTL level USART
Temperature	
Operating:	+10°C to +45°
Storage:	-30°C to +60°C
Humidity	0—99% Rh (non-condensing)
Barometric pressure range	500—1200mbar
Maximum flow rate	1.0 litre/min

#### OUTPUT VALUES<sup>b</sup>

Oxygen range	0—25% O <sub>2</sub>
Oxygen pressure range	0—300mbar ppO <sub>2</sub>
Response time	T90 < 10s (typical)
Accuracy	
ppO <sub>2</sub>	< 2% FS
Temperature	Indication only
Pressure	±5mbar
O <sub>2</sub>	Determined by ppO <sub>2</sub> & pressure accuracy
Resolution	
ppO <sub>2</sub>	0.1mbar
Temperature	0.1°C
Pressure	1mbar
O <sub>2</sub>	0.01%
Lifetime	> 2 years

Other sensor options available on request, email: [technical@sstsensing.com](mailto:technical@sstsensing.com)

**Need help? Ask the expert**  
**Tel: + 44 (0)1236 459 020**  
**and ask for “Technical”**



a) The sensor housing can be cleaned using a damp cloth. Do NOT immerse the sensor in any cleaning media.  
 b) At ambient conditions. All performance measurements are at STP unless otherwise stated. Following extreme temperature fluctuations, re-calibration may be required.

All dimensions shown in mm. Tolerances = ±0.5mm.

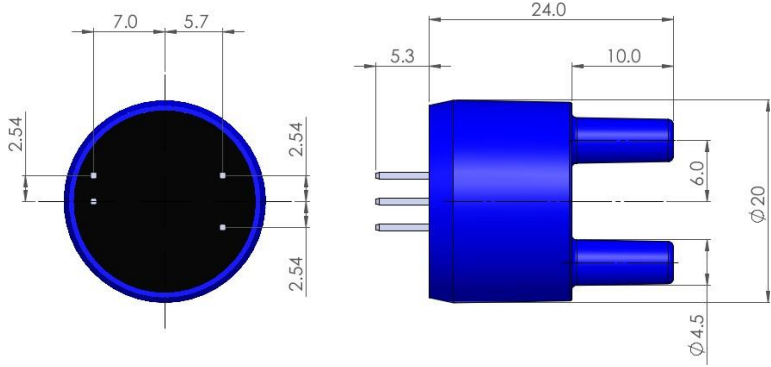

**NOTE:** 4.5mm OD push-fit tubing connectors.

 **ELECTRICAL INTERFACE**

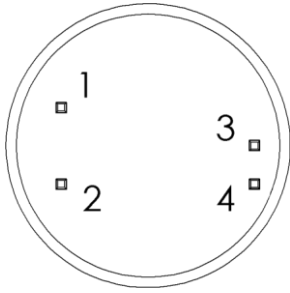

Pin	Designation
1	Vs (+5V)
2	GND (0V)
3	3.3V USART Sensor Transmit
4	3.3V USART Sensor Receive

**CONNECTION:** Four gold-plated pins (0.64mm<sup>2</sup>) on a 2.54mm grid for PCB mounting via sockets or hand soldering using no-clean flux.

**NOTE:** Do NOT put the sensor through a PCB washing process.

**NOTE:** Always apply power to sensor pins 1 and 2 before attempting to communicate on pins 3 and 4.

 The sensor should be treated as an electronic component and handled using the correct ESD handling precautions.

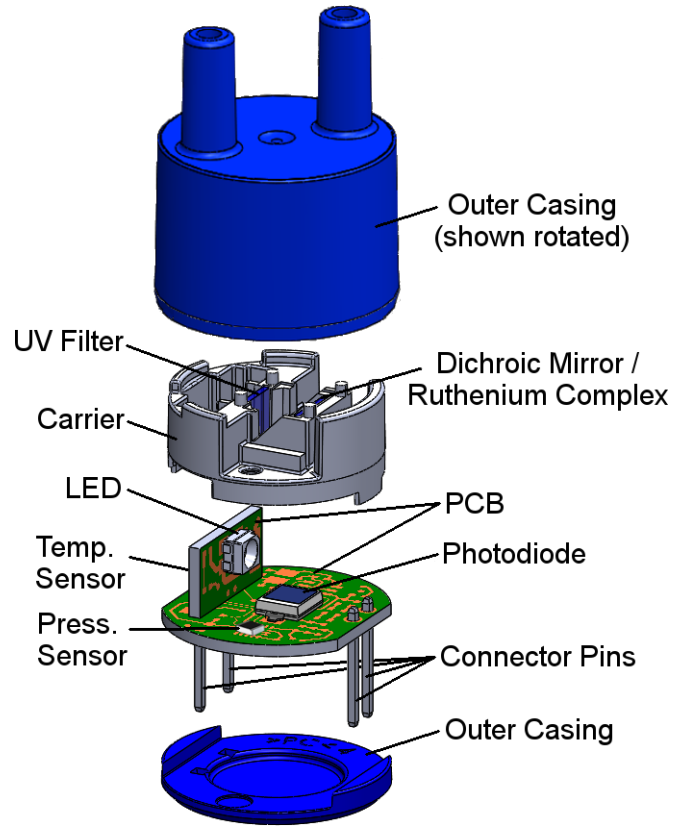

 **ORDER INFORMATION**

Specify the part number below when ordering:

L O X - 0 2 - F

 **CAUTION**

Do not exceed maximum ratings and ensure sensor(s) are operated in accordance with their requirements. Carefully follow all wiring instructions. Incorrect wiring can cause permanent damage to the device. Do NOT use chemical cleaning agents.

**Failure to comply with these instructions may result in product damage.**

**These products must not be used in safety applications where product failure could cause injury or risk to life**

 **INFORMATION**

As customer applications are outside of SST Sensing Ltd.'s control, the information provided is given without legal responsibility. Customers should test under their own conditions to ensure that the equipment is suitable for their intended application.

**For technical assistance or advice, please email:**  
[technical@sstsensing.com](mailto:technical@sstsensing.com)

**General Note:** SST Sensing Ltd. reserves the right to make changes to product specifications without notice or liability. All information is subject to SST Sensing Ltd.'s own data and considered accurate at time of going to print.